

L A Z B O Y[®]
O U T D O O R

Live life Comfortably.[®]

Addyson Square Dining Table

Owner's Manual



, \ R X K D Y D H Q S U R E O Z I P W W K S U R G X F W 2 7 5 (7 8 5 1 , 7 7 Z + (6 7 2 5 (& \$ // 2 8 5 & 8 6 7 2 0 (5 6 (5 9 + 2 7 / , 1 \$ 7

0 R Q G B) U L G D \$ 0 3 0 (6 7

/ D = % R \ S U H J L V W H I D G P I D U N % , R \ F R U S R U D W H G
, Q F / D = % , R \ F R U S R U D W H G

For warranty and other helpful information, please visit www.lazboyoutdoor.com or call 1-877-592-7514, Monday-Friday, 8AM-5PM (EST) or email us at customerservice@lazboyoutdoor.com.

Care and Maintenance

Be careful to never allow water to build up in frames as this will cause corrosion and freeze damage in cold climates. Wash all frames with a solution of mild soap and water. Rinse with clean water and dry with a soft absorbent cloth towel. Frames can be treated with a liquid wax for maximum protection against UV rays and/or salty damp air. If your set includes cushions, slings, and/or an umbrella they may be cleaned by hand with a solution of soap and water with a clean water rinse. (Never machine wash cushions, slings or umbrella covers as this will result in shrinkage or damage).

After cleaning cushions tip on end and allow to drip dry. (Never use a commercial or home dryer to tumble dry fabric goods).





Do not use bleach or solvents to clean any product! This will void the warranty.

Lack of original receipt will void warranty!

CAUTION: Read all the instructions before assembly. Failure to do so may result in faulty assembly and potential injury!

Assemble product on a soft, non-abrasive surface such as a carpet or cardboard to avoid damaging the item. Seek assistance to assemble bulky or heavy items. After final alignment, make sure all bolts and nuts are securely tightened with screw head covers pressed in place.

Note: Do not allow children to play with plastic wraps or small parts to prevent potential choking hazard.

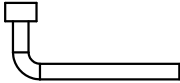
PARTS NO.	PARTS NAME	PARTS	QTY
A	Table top		1
B	Table leg		4
AA	Bolt M6 x 20mm		16
BB	M6 Washer		16
CC	M6 Plastic cap		16
DD	M6 Wrench		1

Assembly Steps:

Step 1. Attach table legs (B) to table top (A) with bolts (AA) and washers (BB). Cover bolts with bolt caps (CC). See Figure 1.

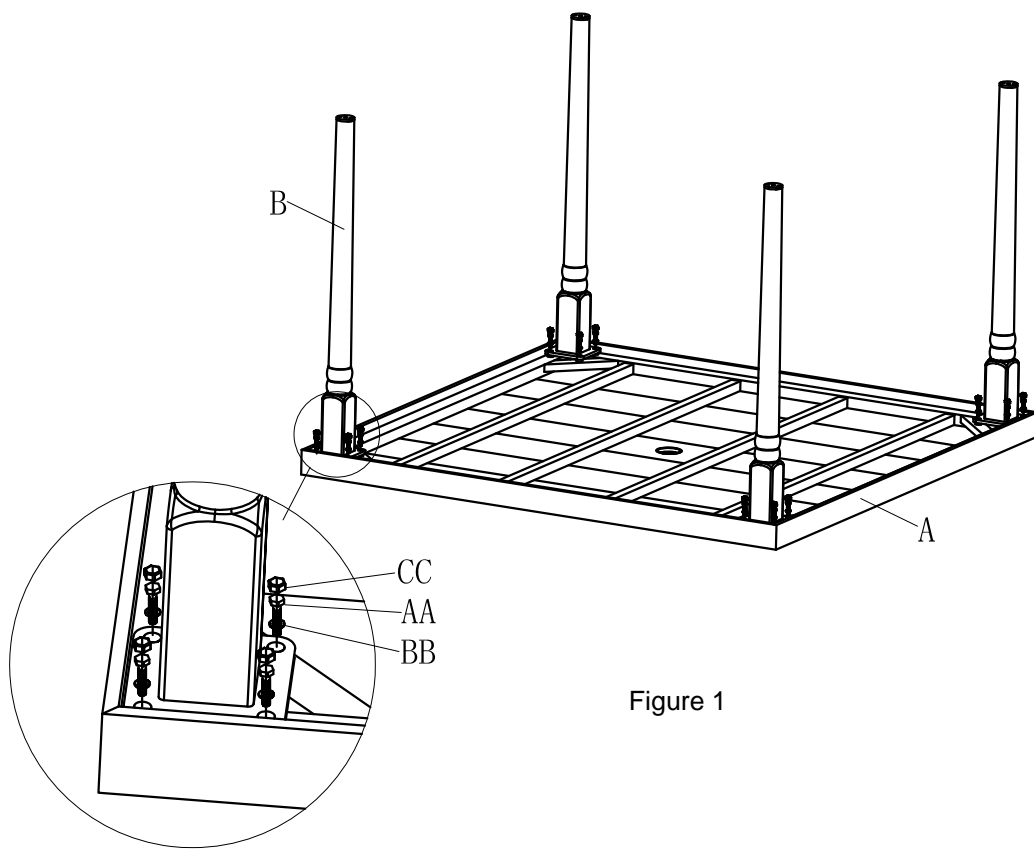

Figure 1

6WS 7XQ WKH WSEIQRKZRXWDEQHDIQRXU HQMR\PHQW
6HHLJKU

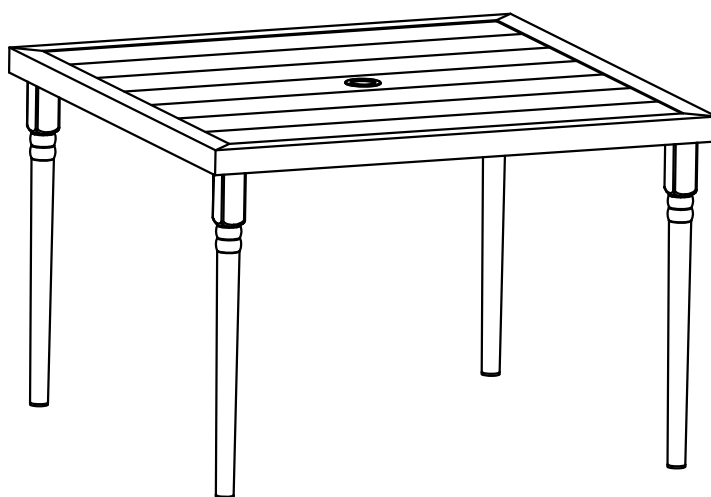

Figure 2